

PACKING 3-VERTEX PATHS IN 2-CONNECTED GRAPHS

Alexander Kelmans

University of Puerto Rico, San Juan, Puerto Rico
Rutgers University, New Brunswick, New Jersey

Abstract

Let $v(G)$ and $\lambda(G)$ be the number of vertices and the maximum number of disjoint 3-vertex paths in G , respectively. We give a construction that provides infinitely many 2-connected, cubic, bipartite, and planar graphs such that $\lambda(G) < \lfloor v(G)/3 \rfloor$.

Keywords: cubic, bipartite, planar, Λ -packing, Λ -factor.

1 Introduction

We consider undirected graphs with no loops and no parallel edges. All notions and facts on graphs, that are used but not described here, can be found in [1, 2, 12].

Given graphs G and H , an H -packing of G is a subgraph of G whose components are isomorphic to H . An H -packing P of G is called an H -factor if $V(P) = V(G)$. The H -packing problem, i.e. the problem of finding in G an H -packing, having the maximum number of vertices, turns out to be NP -hard if H is a connected graph with at least three vertices [3]. Let Λ denote a 3-vertex path. In particular, the Λ -packing problem is NP -hard. Moreover, this problem remains NP -hard even for cubic graphs [6].

Although the Λ -packing problem is NP -hard, i.e. possibly intractable in general, this problem turns out to be tractable for some natural classes of graphs (e.g. [4, 10]). It would be also interesting to find polynomial algorithms that would provide a good approximation solution for the problem. Below (see **1.1**, **1.2**, and **1.4**) are some examples of such results. In each case the corresponding packing problem is polynomially solvable.

Let $v(G)$ and $\lambda(G)$ denote the number of vertices and the maximum number of disjoint 3-vertex paths in G , respectively. Obviously $\lambda(G) \leq \lfloor v(G)/3 \rfloor$.

In [5, 11] we answered the following natural question:

How many disjoint 3-vertex paths must a cubic n -vertex graph have?

1.1 *If G is a cubic graph, then $\lambda(G) \geq \lceil v(G)/4 \rceil$. Moreover, there is a polynomial time algorithm for finding a Λ -packing having at least $\lceil v(G)/4 \rceil$ components.*

Obviously if every component of G is K_4 , then $\lambda(G) = v(G)/4$. Therefore the bound in **1.1** is sharp.

Let \mathcal{G}_2^3 denote the set of graphs with each vertex of degree at least 2 and at most 3.

In [5] we answered (among other results) the following question:

How many disjoint 3-vertex paths must an n -vertex graph from \mathcal{G}_2^3 have?

1.2 *Suppose that $G \in \mathcal{G}_2^3$ and G has no 5-vertex components. Then $\lambda(G) \geq \lceil v(G)/4 \rceil$.*

Obviously **1.1** follows from **1.2** because if G is a cubic graph, then $G \in \mathcal{G}_2^3$ and G has no 5-vertex components.

In [5] we also gave a construction that allowed to prove the following:

1.3 *There are infinitely many connected graphs for which the bound in **1.2** is attained. Moreover, there are infinitely many subdivisions of cubic 3-connected graphs for which the bound in **1.2** is attained.*

The next interesting question is:

How many disjoint 3-vertex paths must a cubic connected graph have?

In [7] we proved the following.

1.4 *Let \mathcal{C}_n denote the set of connected cubic graphs with n vertices and $\lambda_n = \min\{\lambda(G)/v(G) : G \in \mathcal{C}_n\}$. Then for some $c > 0$,*

$$\frac{3}{11}\left(1 - \frac{c}{n}\right) \leq \lambda_n \leq \frac{3}{11}\left(1 - \frac{1}{n^2}\right).$$

The next natural question is:

1.5 Problem *How many disjoint 3-vertex paths must a cubic 2-connected graph have?*

This question is still open (namely, the sharp lower bound on the number of disjoint 3-vertex paths in a cubic 2-connected n -vertex graph is unknown).

There are infinitely many 2-connected and cubic graphs such that $\lambda(G) < \lfloor v(G)/3 \rfloor$.

As to cubic 3-connected graphs, an old open questions here is:

1.6 Problem *Is the following claim true:*

if G is a 3-connected and cubic graph, then $\lambda(G) = \lfloor v(G)/3 \rfloor$?

In [9] we discuss Problem **1.6** and show, in particular, that the claim in **1.6** is equivalent to some seemingly much stronger claims. Here are some results of this kind.

1.7 [9] *The following are equivalent for cubic 3-connected graphs G :*

(z1) $v(G) \equiv 0 \pmod{6} \Rightarrow G$ has a Λ -factor,

(z2) $v(G) \equiv 0 \pmod{6} \Rightarrow$ for every $e \in E(G)$ there is a Λ -factor of G avoiding e ,

(z3) $v(G) \equiv 0 \pmod{6} \Rightarrow$ for every $e \in E(G)$ there is a Λ -factor of G containing e ,

- (z4) $v(G) = 0 \pmod 6 \Rightarrow G - X$ has a Λ -factor for every $X \subseteq E(G)$, $|X| = 2$,
- (z5) $v(G) = 0 \pmod 6 \Rightarrow G - L$ has a Λ -factor for every 3-vertex path L in G ,
- (t2) $v(G) = 2 \pmod 6 \Rightarrow G - \{x, y\}$ has a Λ -factor for every $xy \in E(G)$,
- (f1) $v(G) = 4 \pmod 6 \Rightarrow G - x$ has a Λ -factor for every $x \in V(G)$,
- (f2) $v(G) = 4 \pmod 6 \Rightarrow G - \{x, e\}$ has a Λ -factor for every $x \in V(G)$ and $e \in E(G)$.

In [10] we have shown (in particular) that all claims in **1.7** except for (z5) are true for 3-connected claw-free graphs and (z5) is true for cubic, 2-connected, and claw-free graphs distinct from K_4 (see also [4]).

The problems similar to **1.6** are interesting for 2-connected and cubic graphs having some additional properties. For example,

1.8 Problem *Is $\lambda(G) = \lfloor v(G)/3 \rfloor$ true for every 2-connected, cubic, bipartite, and planar graph ?*

In this paper (see Section 3) we answer the question in **1.8** by giving a construction that provides infinitely many 2-connected, cubic, bipartite, and planar graphs such that $\lambda(G) < \lfloor v(G)/3 \rfloor$ (see also [8]).

2 Some notation, constructions, and simple observations

We consider undirected graphs with no loops and no parallel edges unless stated otherwise. As usual, $V(G)$ and $E(G)$ denote the set of vertices and edges of G , respectively, and $v(G) = |V(G)|$. If X is a vertex subset or a subgraph of G , then let $D(X, G)$ or simply $D(X)$, denotes the set of edges in G , having exactly one end-vertex in X , and let $d(X, G) = |D(X, G)|$. If $x \in V(G)$, then $D(x, G)$ is the set of edges in G incident to x , $d(x, G) = |D(x, G)|$, $N(x, G) = N(x)$ is the set of vertices in G adjacent to x , and $\Delta(G) = \max\{d(x, G) : x \in V(G)\}$. If $e = xy \in E(G)$, then let $End(e) = \{x, y\}$. Let $Cmp(G)$ denote the set of components of G and $cmp(G) = |Cmp(G)|$.

Let $\mathcal{C}(k)$ denote the set of cubic k -connected graphs, $k \in \{1, 2, 3\}$.

Let A and B be disjoint graphs, $a \in V(A)$, $b \in V(B)$, and $\sigma : N(a, A) \rightarrow N(b, B)$ be a bijection. Let $Aa\sigma bB$ denote the graph $(A - a) \cup (B - b) \cup \{x\sigma(x) : x \in N(a, A)\}$. We usually assume that $N(a, A) = \{a_1, a_2, a_3\}$, $N(b, B) = \{b_1, b_2, b_3\}$, and $\sigma(a_i) = b_i$ for $i \in \{1, 2, 3\}$ (see Fig. 1).

We also say that $Aa\sigma bB$ is obtained from B by replacing vertex b by $(A - a)$ according to σ .

Let B be a cubic graph and $X \subseteq V(B)$. Let $A(v)$, where $v \in X$, be a graph, a^v be a vertex of degree three in $A(v)$, and $A^v = A(v) - a^v$. By using the above operation, we

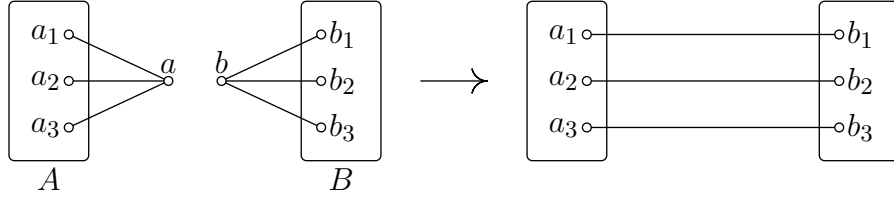

Figure 1: $Aa\sigma bB$

can build a graph $G = B\{(A(v), a^v) : v \in X\}$ by replacing each vertex v of B in X by A^v assuming that all $A(v)$'s are disjoint. Let $D^v = D(A^v, G)$. For each $u \in V(B) \setminus X$ let $A(u)$ be the graph having exactly two vertices u, a^u and exactly three parallel edges connecting u and a^u . Then $G = B\{(A(v), a^v) : v \in X\} = B\{(A(v), a^v) : v \in V(B)\}$. If, in particular, $X = V(B)$ and each $A(v)$ is a copy of K_4 , then G is obtained from B by replacing each vertex by a triangle.

Let $E' = E(G) \setminus \cup\{E(A^v) : v \in V(B)\}$. Obviously, there is a unique bijection $\alpha : E(B) \rightarrow E'$ such that if $uv \in E(B)$, then $\alpha(uv)$ is an edge in G having one end-vertex in A^u and the other in A^v .

Let P be a Λ -packing in G . For $uv \in E(B)$, $u \neq v$, we write $u \dashv^P v$ or simply, $u \dashv v$, if P has a 3-vertex path L such that $\alpha(uv) \in E(L)$ and $|V(A^u) \cap V(L)| = 1$. Let P^v be the union of components of P that meet D^v in G .

Obviously

2.1 *Let k be an integer and $k \leq 3$. If A and B above are k -connected, cubic, bipartite, and planar graphs, then $Aa\sigma bB$ is also a k -connected, cubic, bipartite, and planar graph, respectively.*

From **2.1** we have:

2.2 *Let k be an integer and $k \leq 3$. If B and each A_v is a k -connected, cubic, bipartite, and planar graphs, then $B\{(A_v, a_v) : v \in V(B)\}$ is also a k -connected, cubic, bipartite, and planar graph, respectively.*

Let A^1, A^2, A^3 be three disjoint graphs, $a^i \in V(A^i)$, and $N(a^i, A^i) = \{a_1^i, a_2^i, a_3^i\}$, where $i \in \{1, 2, 3\}$. Let $F = Y(A^1, a^1; A^2, a^2; A^3, a^3)$ denote the graph obtained from $(A^1 - a^1) \cup (A^2 - a^2) \cup (A^3 - a^3)$ by adding three new vertices z_1, z_2, z_3 and the set of nine new edges $\{z_j a_j^i : i, j \in \{1, 2, 3\}\}$ (see Fig. 2). In other words, if $B = K_{3,3}$ is the complete (X, Z) -bipartite graph with $X = \{x_1, x_2, x_3\}$ and $Z = \{z_1, z_2, z_3\}$, then F is obtained from the B by replacing each vertex x_i in X by $A^i - a^i$ so that $D(A^i - a^i, F) = \{a_j^i z_j : j \in \{1, 2, 3\}\}$. Let $D^i = D(A^i - a^i, F)$. If P is a Λ -packing of F , then let $P^i = P^i(F)$ be the union of components of P meeting D^i and $E^i = A^i(P) = E(P) \cap D^i$, $i \in \{1, 2, 3\}$.

If each (A^i, a^i) is a copy of the same (A, a) , then we write $Y(A, a)$ instead of $Y(A^1, a^1; A^2, a^2; A^3, a^3)$.

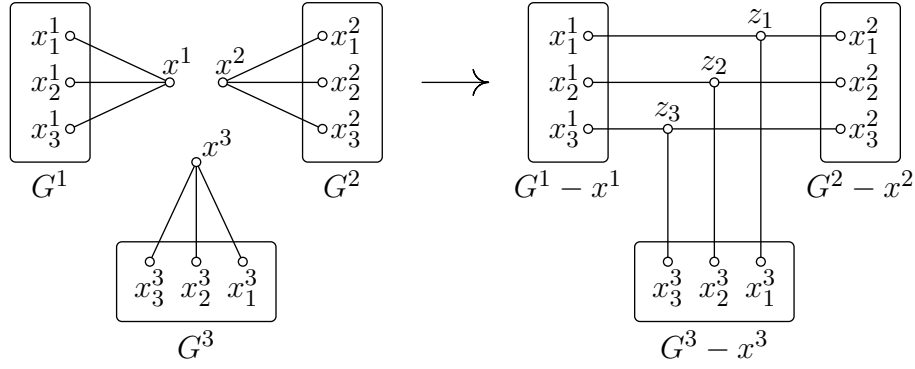

Figure 2: $Y(A^1, a^1; A^2, a^2; A^3, a^3)$

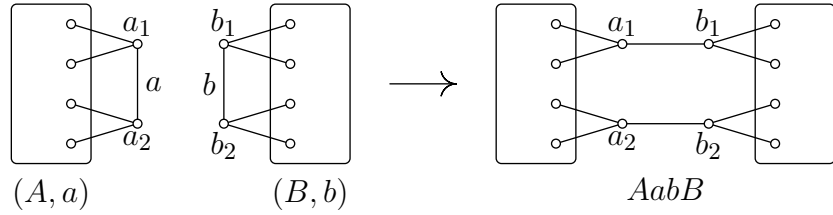

Figure 3: $AabB$

From **2.2** we have, in particular:

2.3 *Let k be an integer and $k \leq 3$. If each A^i above is a k -connected, cubic, and bipartite graph, then $Y(A^1, a^1; A^2, a^2; A^3, a^3)$ (see Fig. 2) is also a k -connected, cubic, and bipartite graph, respectively.*

Let A and B be disjoint graphs, $a = a_1a_2 \in E(A)$, and $b = b_1b_2 \in E(B)$. Let $AabB$ be the graph obtained from $(A - a) \cup (B - b)$ by adding two new edges a_1b_1, a_2b_2 (see Fig. 3). Let $Aa|bB$ be the graph obtained from $AabB$ by replacing edge $a_i b_i$ by a 3-vertex path $a_i z_i b_i$ for each $i \in \{1, 2\}$ and by adding a new edge $z = z_1 z_2$. We call z the *middle edge* of $Aa|bB$ (see Fig. 4).

It is easy to see the following.

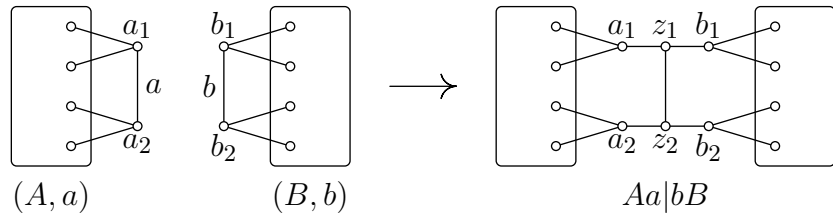

Figure 4: $Aa|bB$

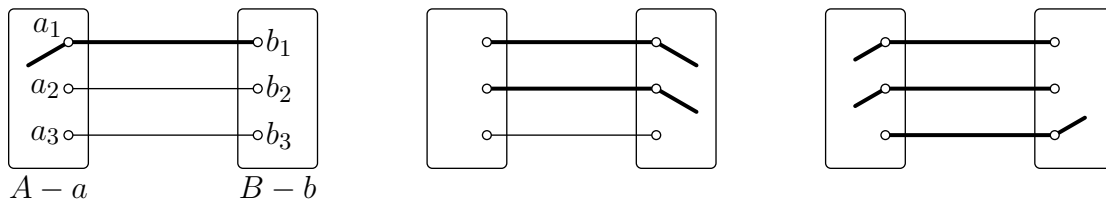

Figure 5:

2.4 Let k be an integer and $k \leq 2$. If A and B are k -connected, cubic, bipartite, and planar graphs, then both $AabB$ and $Aa|bB$ are also a k -connected, cubic, bipartite, and planar graph, respectively.

We will use the following simple observation.

2.5 Let A and B be disjoint graphs, $a \in V(A)$, $N(a, A) = \{a_1, a_2, a_3\}$, $b \in V(B)$, $N(b, B) = \{b_1, b_2, b_3\}$, and $G = Aa\sigma bB$, where each $\sigma(a_i) = b_i$ (see Fig. 1). Let P be a Λ -factor of G (and so $v(G) = 0 \pmod 3$) and P' be the Λ -packing of G consisting of the components (3-vertex paths) of P that meet $\{a_1b_1, a_2b_2, a_3b_3\}$.

(a1) Suppose that $v(A) = 0 \pmod 3$, and so $v(B) = 2 \pmod 3$. Then one of the following holds (see Fig 5):

(a1.1) P' has exactly one component that has two vertices in $A - a$, that are adjacent (and, accordingly, exactly one vertex in $B - b$),

(a1.2) P' has exactly two components and each component has exactly one vertex in $A - a$ (and, accordingly, exactly two vertices in $B - b$, that are adjacent),

(a1.3) P' has exactly three components L_1, L_2, L_3 and one of them, say L_1 , has exactly one vertex in $A - a$ and each of the other two L_2, L_3 , has exactly two vertices in $A - a$, that are adjacent (and, accordingly, L_1 has exactly two vertices in $B - b$, that are adjacent, and each of the other two L_2, L_3 , has exactly one vertex in $B - b$).

(a2) Suppose that $v(A) = 1 \pmod 3$, and so $v(B) = 1 \pmod 3$. Then one of the following holds (see Fig 6):

(a2.1) $P' = \emptyset$,

(a2.2) P' has exactly two components, say L_1, L_2 , and one of the them, say L_1 , has exactly one vertex in $A - a$ and exactly two vertices in $B - b$, that are adjacent, and the other component L_2 has exactly two vertices in $A - a$, that are adjacent, and exactly one vertex in $B - b$,

(a2.3) P' has exactly three components L_1, L_2, L_3 and either each L_i has exactly one vertex in $A - a$ (and, accordingly, has exactly two vertices in $B - b$, that are adjacent) or each L_i has exactly two vertices in $A - a$, that are adjacent (and, accordingly, has exactly one vertex in $B - b$).

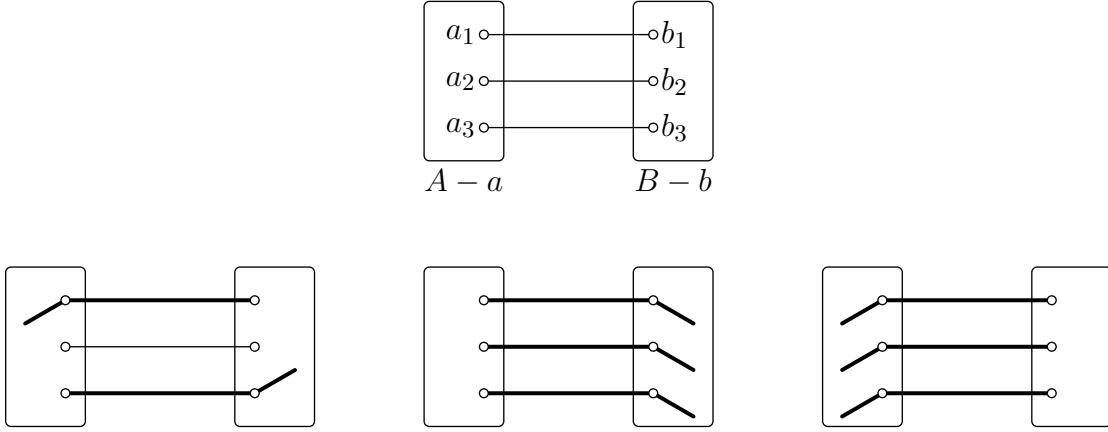

Figure 6:

3 Λ -packings in cubic 2-connected graphs

3.1 Cubic, bipartite, and 2-connected graphs

3.1 Let $G = Y(A^1, a^1; A^2, a^2; A^3, a^3)$ (see Fig. 2) and P be a Λ -factor of G . Suppose that each A^i is a cubic graph and $v(A^i) = 0 \pmod 6$. Then $\text{cmp}(P^i) \in \{1, 2\}$ for every $i \in \{1, 2, 3\}$.

Proof Let $i \in \{1, 2, 3\}$. Since D^i is a matching and P^i consists of the components of P meeting D^i , clearly $\text{cmp}(P^i) \leq 3$. Since $v(A^i) = -1 \pmod 6$, we have $\text{cmp}(P^i) \geq 1$. It remains to show that $\text{cmp}(P^i) \leq 2$. Suppose, on the contrary, that $\text{cmp}(P^1) = 3$.

Since P is a Λ -factor of G and $v(A^1 - a^1) = -1 \pmod 6$, clearly $v(P^1) \cap V(A^1 - a^1) = 5$ and we can assume (because of symmetry) that P_1 consists of three components $a_3^1 z_3 a_3^2$, $z_1 a_1^1 y^1$, and $z_2 a_2^1 u^1$ for some $y^1, u^1 \in V(A^1)$. Then $\text{cmp}(P^3) = 0$, a contradiction. \square

3.2 Let A be a graph, $e = aa_1 \in E(A)$, and $G = Y(A, a)$ (see Fig. 2). Suppose that

(h1) A is cubic,

(h2) $v(A) = 0 \pmod 6$, and

(h3) a has no Λ -factor containing $e = aa_1$.

Then $v(G) = 0 \pmod 6$ and G has no Λ -factor.

Proof (uses 3.1). Suppose, on the contrary, that G has a Λ -factor P . By definition of $G = Y(A, a)$, each A^i is a copy of A and edge $e^i = a^i a_1^i$ in A^i is a copy of edge $e = aa_1$ in A . By 3.1, $\text{cmp}(P^i) \in \{1, 2\}$ for every $i \in \{1, 2, 3\}$. Since P is a Λ -factor of G and $v(A^i - x^i) = -1 \pmod 6$, clearly $E(P) \cap D^i$ is an edge subset of a Λ -factor of A^i for every $i \in \{1, 2, 3\}$ (we assume that edge $z_j a_j^i$ in G is edge $a^i a_j^i$ in A^i). Since $a^1 a_1^1$ belongs to no Λ -factor of A^i for every $i \in \{1, 2, 3\}$, clearly $E(P) \cap \{z_1 a_1^1, z_1 a_1^2, z_1 a_1^3\} = \emptyset$. Therefore $z_1 \notin V(P)$, and so P is not a Λ -factor of G , a contradiction. \square

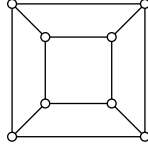

Figure 7: The cube

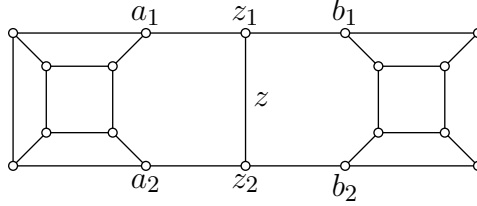

Figure 8: $K = Q_1q_1|q_2Q_2$, $v(K) = 18$

3.3 Suppose A and B are cubic graphs and $v(A) = 2 \pmod 6$, $v(B) = 2 \pmod 6$. Let $G = Aa|bB$ with the middle edge $z = (z_1z_2)$ (see Fig. 4). Then $v(G) = 0 \pmod 6$ and G has no Λ -factor containing edge z .

Proof Obviously $v(G) = 0 \pmod 6$. Let P be a Λ -factor of G . Let $Z = \{z_1a_1, z_2a_2\}$. Since P is a Λ -factor of G and $v(A) = 2 \pmod 6$, clearly $E(P) \cap Z \neq \emptyset$.

Suppose that $|E(P) \cap Z| = 1$, say $E(P) \cap Z = z_1a_1$. Since P is a Λ -factor of G and $v(A) = 2 \pmod 6$, clearly $z_1a_1a \in P$ for some $a \in V(A)$. Then $z \notin E(P)$.

Now suppose that $|E(P) \cap Z| = 2$. Again since P is a Λ -factor of G and $v(A) = 2 \pmod 6$, clearly $a_iz_iz_i \in P$ for every $i \in \{1, 2\}$ and some $y_1, y_2 \in V(A)$, $y_1 \neq y_2$. Since $y_1 \neq y_2$ and $z = z_1z_2 \in E(G)$, clearly $z \notin E(P)$. \square

A minimum simple cubic graph H with $v(H) = 2 \pmod 6$ has 8 vertices. Therefore by **3.3**, a minimum simple cubic graph M with an edge z , avoidable by every Λ -factor of M , that can be obtained by construction $Aa|bB$, has 18 vertices

The graph-skeleton Q of the cube is the only simple, cubic, and bipartite graph with 8 vertices (see Fig. 7). Moreover, Q is planar. Therefore if both A and B are disjoint copies Q_1 and Q_2 of Q , then by **3.3**, $K = Q_1q_1|q_2Q_2$ has no Λ -factor, containing the middle edge z of K , and $v(K) = 18$ (see Fig. 8). Moreover, since Q is 2-connected, bipartite, and planar, K is also 2-connected, bipartite, and planar.

3.4 Suppose that H is a cubic graph, $v(H) = 0 \pmod 6$, $h \in E(H)$, and H has no Λ -factor containing h . Let $G = Y(H, h)$. Then $v(G) = 0 \pmod 6$ and G has no Λ -factor.

Proof Obviously (H, h) satisfies (h1), (h2), and (h3) of **3.2**. Therefore by **3.2**, G has no Λ -factor. \square

3.5 There are infinitely many graphs G such that G is 2-connected, cubic, and bipartite, $v(G) = 0 \pmod 6$, and G has no Λ -factor.

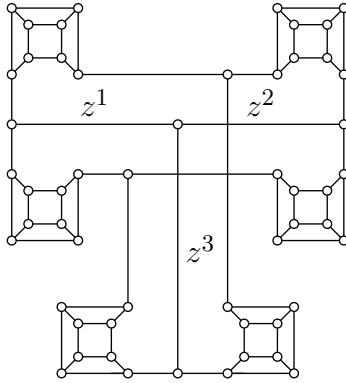

Figure 9: $R = Y(K, k)$, $v(R) = 54$

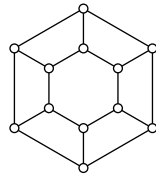

Figure 10:

Proof Follows immediately from **2.1**, **2.4**, **3.2**, **3.3**, and **3.4**. □

By **3.4**, $R = Y(K, k)$ has no Λ -factor, where k is a vertex in K incident to the middle edge z of K (see Fig. 9). Obviously, R is a 2-connected, cubic, bipartite graph and $v(R) = 54$. The graph R is a smallest simple graph with these properties provided by the above construction.

3.2 Cubic, bipartite, planar, and 2-connected graphs

3.6 Let A and B be cubic graphs, $v(A) = 0 \pmod 6$ and $v(B) = 0 \pmod 6$, $a \in V(A)$, $N(a, A) = \{a_1, a_2, a_3\}$, $b \in V(B)$, $N(b, B) = \{b_1, b_2, b_3\}$. Let $H = Aa\sigma bB$, where $\sigma(a_i) =$

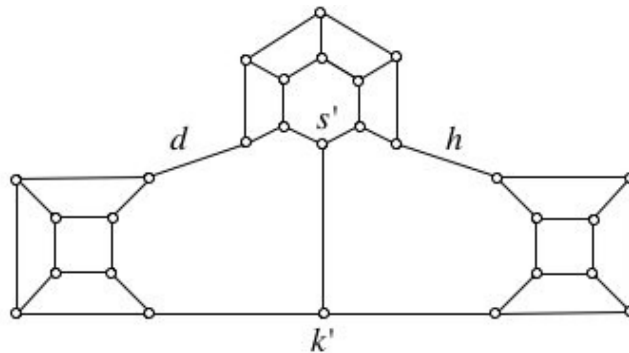

Figure 11: $H = Kk\sigma sS$, $v(H) = 28$

b_i (see Fig. 1). Suppose that A has no Λ -factor containing aa_1 . Then $v(H) = 4 \pmod 6$ and $H - b_2$ has no Λ -factor avoiding $h = a_3b_3$.

Proof Let P be a Λ -factor of $H - b_2$. Since $v(A - a) = -1 \pmod 6$ and A has no Λ -factor containing aa_1 , clearly $b_3a_3z \in P$ for some vertex z in A adjacent to a_3 , and so $h = a_3b_3 \in E(P)$. \square

3.7 Suppose that A and B are disjoint cubic graph, $v(A) = 0 \pmod 6$, $v(B) = 4 \pmod 6$, $a = a_1a_2 \in E(A)$, $x \in V(B)$, $b = b_1b_2 \in E(B)$, A has no Λ -factor containing a , and $B - x$ has no Λ -factor avoiding b (and so x is not incident to b). Let $G = AabB$ (Fig 3). Then $v(G) = 4 \pmod 6$ and $G - x$ has no Λ -factor.

Proof Obviously $v(G) = 4 \pmod 6$. Suppose, on the contrary, that $G - x$ has a Λ -factor P . Since $B - x$ has no Λ -factor and $v(G) = 0 \pmod 6$, clearly $\{a_1b_1, a_2b_2\} \subseteq E(P)$ and there are vertices $a_3 \in V(A)$ and $b_3 \in V(B)$ such that (up to symmetry) $a_3a_1b_1, a_2b_2b_3 \in P$. Then $(P \cap A) \cup a_3a_1a_2$ is a Λ -factor of A containing a , a contradiction. \square

3.8 Suppose that A and B are disjoint cubic graph, $v(A) = 2 \pmod 6$, $v(B) = 4 \pmod 6$, $a = a_1a_2 \in E(A)$, $b = b_1b_2 \in E(B)$, and $B - b_1$ has no Λ -factor. Let $G = AabB$ (Fig 3). Then $v(G) = 0 \pmod 6$ and G has no Λ -factor avoiding a_2b_2 .

Proof Suppose, on the contrary, that G has a Λ -factor P avoiding a_2b_2 . Since P is a Λ -factor of G and $v(A) = 2 \pmod 6$, clearly $E(P) \cap \{a_1b_1, a_2b_2\} = a_1b_1$ and $a_3a_1b_1 \in P$ for some $a_3 \in V(A - \{a_1, a_2\})$. Then $P \cap B$ is a Λ -factor of $B - b_1$ a contradiction. \square

3.9 Suppose that A and B are disjoint cubic graph, $v(A) = 0 \pmod 6$, $v(B) = 0 \pmod 6$, $a = a_1a_2 \in E(A)$, $b = b_1b_2 \in E(B)$, and A has no Λ -factor containing a , and B has no Λ -factor avoiding b . Let $G = AabB$ (Fig 3). Then $v(G) = 0 \pmod 6$ and G has no Λ -factor.

Proof Suppose, on the contrary, that G has a Λ -factor P . Since P is a Λ -factor of G and B has no Λ -factor avoiding b , clearly $\{a_1b_1, a_2b_2\} \subseteq E(P)$ and there are vertices $a_3 \in V(A)$ and $b_3 \in V(B)$ such that (up to symmetry) $a_3a_1b_1, a_2b_2b_3 \in P$. Then $(P \cap A) \cup a_3a_1a_2$ is a Λ -factor of A containing a , a contradiction. \square

3.10 There are infinitely many graphs G such that $v(G) = 0 \pmod 6$, G is 2-connected, cubic, bipartite, and planar, and G has no Λ -factor.

Proof Follows from **2.1**, **2.4**, **3.3**, **3.6**, **3.7**, **3.8**, and **3.9**. \square

Let \mathcal{CBP} denote the set of cubic, bipartite, planar, and 2-connected graphs. The smallest graph G in \mathcal{CBP} with $v(G) = 0 \pmod 6$ is the six-prism S , $v(S) = 12$ (see Fig. 10). Therefore by **3.6**, the smallest graph H in \mathcal{CBP} that has properties, guaranteed

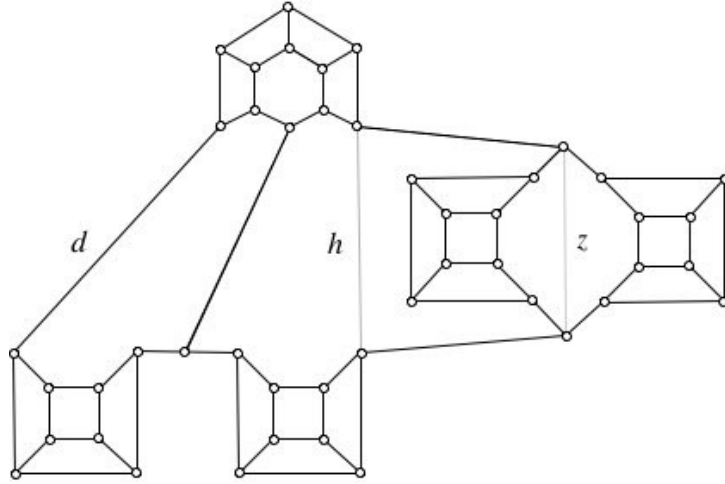

Figure 12: $D = KzhH$, $v(D) = 46$

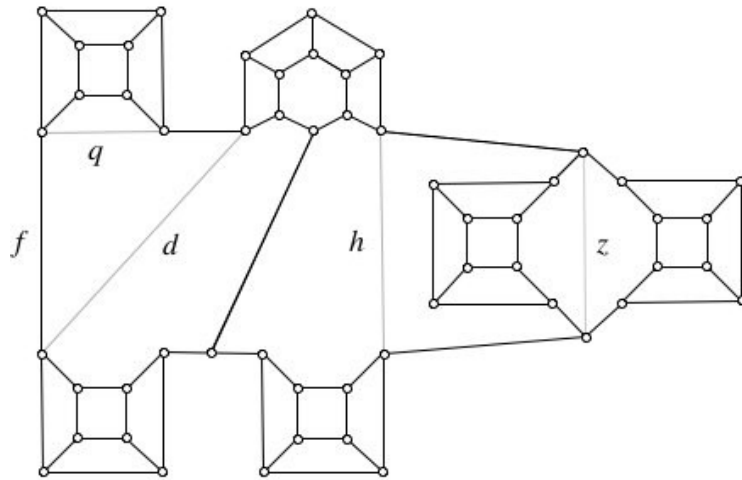

Figure 13: $F = Qqd(KzhH)$, $v(F) = 54$

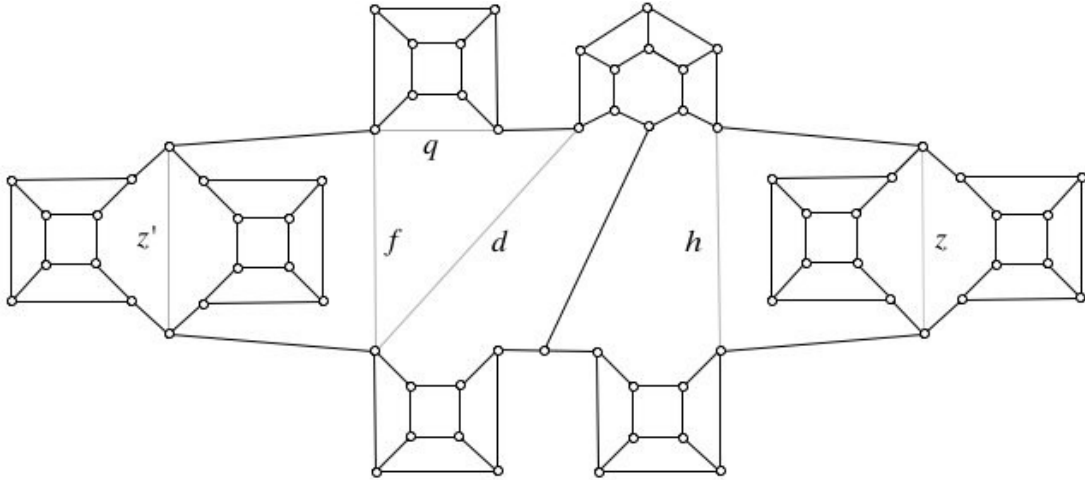

Figure 14: $N = Kz'fF$, $v(N) = 72$

by **3.6**, and that can be obtained by construction $Aa\sigma bB$ (see Fig 1), is $H = Kk\sigma sS$, $v(H) = 28$ (see Fig 11). Accordingly, by **3.7**, the smallest graph D in \mathcal{CBP} that has properties, guaranteed by **3.7**, and that can be obtained by construction $AabB$ (see Fig 3), is $D = KzhH$, $v(D) = 46$ (see Fig 12). By **3.8**, the smallest graph F in \mathcal{CBP} that has properties, guaranteed by **3.8**, and can be obtained by construction $AabB$, is $F = QqdD$, $v(F) = 54$ (see Fig. 13). Now by **3.9**, the smallest graph N in \mathcal{CBP} with $v(N) = 0 \pmod 6$ that has no Λ -factor, and that can be obtained by the above construction, is $N = Kz'fF$, $v(N) = 72$ (see Fig. 14).

References

- [1] J.A. Bondy and U.S.R. Murty, *Graph Theory*, Springer, 2007.
- [2] R. Deistel, *Graph Theory*, Springer-Verlag, New York, 2005.
- [3] P. Hell and D. Kirkpatrick, Packing by complete bipartite graphs, *SIAM J. Algebraic Discrete Math.* **7** (1986), 199–209.
- [4] A. Kaneko, A. Kelmans, T. Nishimura, On packing 3-vertex paths in a graph, *J. Graph Theory* **36** (2001) 175–197.
- [5] A. Kelmans, Packing k -edge trees in graphs of restricted degrees, *J. Graph Theory* **55** (2007) 306–324 (also *DIMACS Research Report 2000–44*, Rutgers University (2000)).
- [6] A. Kelmans, Packing a k -path in a cubic graph is NP-hard for $k \geq 3$, manuscript, 2001; presented at the DIMACS conference “Graph Partition”, July 2000.

- [7] A. Kelmans, Packing 3-vertex paths in connected cubic graphs, manuscript, 2002; presented at the 34th Southeastern International Conference on Combinatorics, Graph Theory and Computing, March, 2003.
- [8] A. Kelmans, On Λ -packings in 2-connected graphs, *RUTCOR Research Report 21–2005*, Rutgers University (2005).
- [9] A. Kelmans, On Λ -packings in 3-connected graphs, *RUTCOR Research Report 23–2005*, Rutgers University (2005).
- [10] A. Kelmans, On Λ -packings in claw-free graphs, *RUTCOR Research Report 24–2007*, Rutgers University (2007).
- [11] A. Kelmans and D. Mubayi, How many disjoint 2-edge paths must a cubic graph have ? *Journal of Graph Theory*, **45** (2004) 57–79 (also *DIMACS Research Report 2000–23*, Rutgers University (2000)).
- [12] D. West, *Introduction to Graph Theory*, Prentice Hall, 2001.